

UBIBOT

Smart Leak Detector LD1

User Manual

This user manual serves as a general guidance for all types of UBIBOT® Smart Water Leak Detector. Some features, which are marked with asterisk, are available only for specific versions. Please refer to related instructions according to the version you purchased.

PACKAGE LIST



① Device

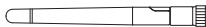

② External antenna ①

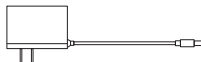

③ Adapter

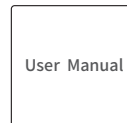

④ User manual

Note:① Please tighten the antenna before use.

INTRODUCTION

1. Basic Features Introduction

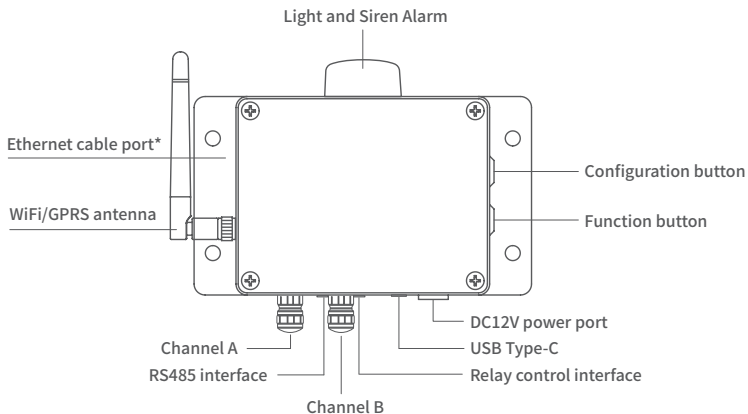

2. Screen Icons Introduction

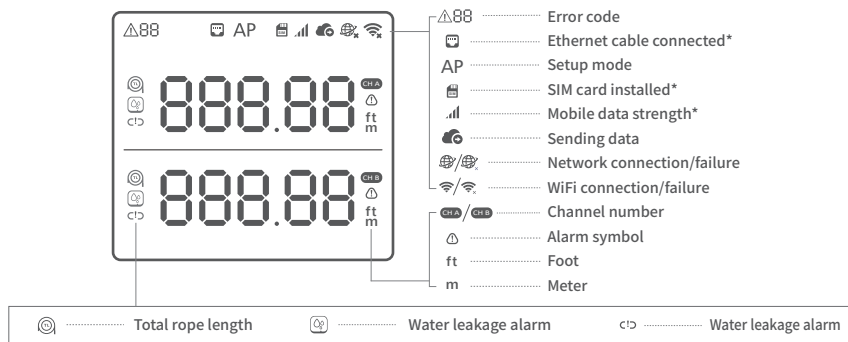

3. Device Operations

- Switch On/Off** After the power is plugged in/unplugged, the device will Switch On/Off automatically.
- Setup Mode** With the device switched on, press and hold the Configuration button for about 5 seconds until the AP icon flashes on the screen. Release at this time to enter the setup mode.
- Manual Data Synchronization** With the device switched on, press the Function button once to trigger a manual data sync. The 📶 icon will flash while the data is being transferred.
- Pause Alarm** When the device alarm has been triggered, click the Configuration button to suspend the alarm. The alarm function will be restored after 5 minutes by default. This timeframe can be set on the platform.
- Display Backlight** Press any key to light the backlight of the device. Press the Configuration button and Function button at the same time to keep the backlight bright.
- Switch On/Off Voice Guide** Double press the Configuration button to enable or disable the voice guide.
- Switch Meter/Foot** Double click the function key to switch the unit (meter/foot).
- Reset to Default Settings** With the device switched on, press and hold the menu button and power buttons together for at least 8 seconds.

DEVICE SETUP OPTIONS

Option 1: Using Mobile App

Download the App from www.ubibot.com/setup, or search for 'Ubibot' on the AppStore or Google Play.



We recommend you try to use the PC Tools in case the App setup fails, because the failure may be due to mobile phone incompatibility. The PC Tools is much easier to operate and suitable for both Mac and Windows.

Option 2: Using PC Tools

Download the tool from www.ubibot.com/setup.

This Tool is a desktop app for device setup. It is also helpful in checking setup failure reasons, MAC address, and offline charts. You can also use it to export offline data stored in the device internal memory.

SETUP USING THE APP FOR WiFi CONNECTION

Launch the App and log in. On the home page, tap "+" to start adding your device. Then please follow the in-app instructions to complete the setup. You can also view the demonstration video at www.ubibot.com/setup for step by step guidance.



Add your device

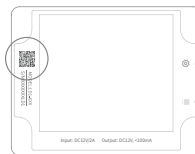

Scan the QR code

Via our app and web console (<http://console.ubibot.com>), you are able to view the readings as well as configure your device, such as create alert rules, set data syncinterval, etc. You can find and watch the demonstration videos at www.ubibot.com/setup.

SETUP USING THE APP FOR MOBILE NETWORK *

Before you set up the device on mobile data, please check the APN information of the SIM card used for the UbiBot device.

An APN (Access Point Name) provides the details your device needs to connect to mobile data through your network operator. APN details differ by network and you will need to get these from your network operator.

With the device off, insert the SIM card as indicated in the picture. Launch the app and log in. Tap the "+" to start setting up the device. Please follow the in-app instructions to complete the setup process. Please note, the setup will fail if you don't have data allowance.

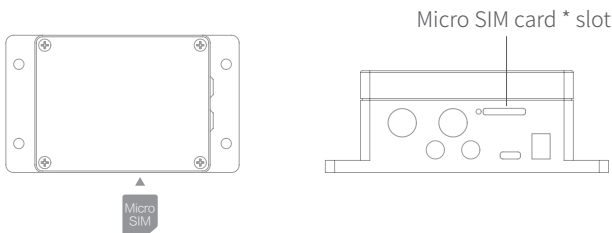

SETUP USING THE APP FOR ETHERNET CABLE CONNECTION*

STEP 1. Connect the device with power supply and plug the Ethernet cable.

STEP 2. Launch the app and log in. On the home page, tap "+" to start adding your device. Then please follow the in-app instructions to complete the setup. You can also view the demonstration video at www.ubibot.com/setup for step by step guidance.

SETUP USING PC TOOLS

- STEP 1.** Launch the App and log in. With the device switched on, use the Type-C USB cable provided to connect your device to the computer. The PC Tools will automatically scan and recognize the product ID and enter the device page.
- STEP 2.** Click "Network" on the left menu bar. There, you are able to set up the device on WiFi for all the models. For the SIM or Ethernet cable setup, please click on the corresponding button to continue.

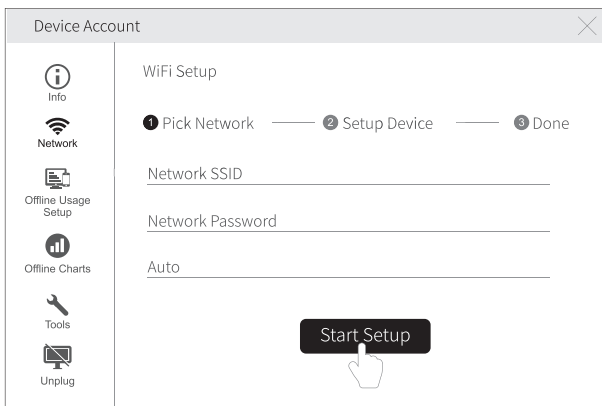

RS485 COMMUNICATION

The default mode is the RS485 communication slave mode. If the external sensor collection time is set in the platform, the master mode for data collection will be activated and the slave mode will be turned off automatically. If the device has been networked, the setting parameters are set by the platform.

For more details, please contact your local distributor or online document.

DEVICE USE

1. Device Connection

① **Power supply:** Please use the matching power adapter. The Type-C interface only supports USB communication.

② **Detection rope:** Please choose the combination of detection ropes according to the actual situation, the longest can support 100 m. Before accessing, please unscrew the termination end on the lead wire of the equipment, and screw the termination end at the end of the detection rope after accessing it to detect normally.

*Note: When deploying the detection rope, please make it as close to the ground as possible.

③ **RS485 interface:** Optional RS485 adapter cable can be used to connect the device with the host computer and establish communication between the two, or to directly connect the external smoke probe or the temperature and humidity probe. The above connections cannot work at the same time.



④ **Relay control:** DC3.5mm interface, output 12V (<100mA) when the device alarm is on. Can be externally connected easily to the sound and light alarm, or output other voltage through the solid state relay. If you click the configuration key to shut down the alarm function, the relay control output 12V will be closed at the same time.







2. Device Alarm

① **Leakage alarm:** After the detection rope is immersed in a non-corrosive conductive water solution, the water immersion position will be calculated and displayed on the screen in real time, and, at the same time, the alarm will be triggered. Single point leaks can be measured at the exact location, if multiple leaks are detected at the same time, the display is between the maximum and minimum distance.

② **Disconnection alarm:** After the detection rope is disconnected, the disconnection alarm will be triggered and displayed on the screen ---, ---.

*Note: The equipment is outfitted with the termination end at the factory; if unscrewed, it will automatically trigger the disconnection alarm.

DEVICE SPECIFICATION

 WiFi 2.4GHz, channel 1-13	 Flame resistant ABS + PC
 Supports Micro SIM card (15 x 12 x 0.8mm)*	 Type-C, DC 12V/1A power supply
 Support Ethernet RJ-45 port (10/100 Mbps)*	 Built-in memory: 300,000 sending data
 Auto-sensing Half/Full Duplex Switched Port*	 115mm x 90mm x 55mm
 Device working environment: -20 to 60°C, 10-90%RH	 Non-corrosive conductive liquid

ERROR CODES

- 02 WiFi Connection Failed: Please refer to the Troubleshooting section 3.
- 03 Failed to Connect to Server: Please refer to the Common Questions at <https://www.ubibot.com/category/faqs/>
- 04 Device Activation Failed: Please refer to the Troubleshooting section 1.
- 05 Data Save Failure: This can happen when the power is disrupted while data is being saved.
- 07 Data Sync Failed: Please refer to the Troubleshooting section 3.
- 08 No SIM Card Found: Please check the SIM card is correctly inserted.
- 09 Mobile Data Network Failure: Please check your SIM card is set up correctly and has been activated.
- 10 Network cable* not detected: Please check if your network cable* is plugged into the device.
- 11 Network cable* connection failure: Please check if your network cable* is working properly.
- 12 IP address conflict: Please check whether your IP address is in conflict with other devices.

FAQ

1. Device network configuration failure reasons

- ① Please check whether the WiFi account password is correct;
- ② Please check whether the router is working properly and the network connection is normal;
- ③ Please make sure the device has entered the WiFi configuration mode;
- ④ Please check whether the WiFi band is 2.4GHz and the channel is between 1~13;
- ⑤ Please check the WiFi channel width is set to 20MHz or auto mode;
- ⑥ WiFi security type: LD1 supports OPEN, WEP and WPA/WPA2-personal;
- ⑦ Poor signal strength, please check the WiFi or cell phone data traffic signal strength.

2. Ethernet network* configuration failure reasons

- ① Please check whether the network cable is properly connected to the equipment;
- ② whether the network cable is intact;
- ③ whether the connected network can access the Internet;

If the above points are not abnormal, and you still cannot activate the device, you need to check whether the network environment allows DHCP (automatic IP allocation) devices to access the network; or re-scan the device QR code, select Ethernet access (advanced mode), and follow the APP prompts to manually assign IP to the device.

3. Reasons for failure to send device data

- ① Check whether the router is working properly;
- ② If using the mobile data traffic provided by the SIM card* inside the device, you need to check

whether the SIM card* is activated; if the SIM card* is activated, check whether the power supply of the device is normal; also check whether the amount of the mobile data traffic provided by the device SIM card* is sufficient for the data transfer.

4. Can the device be used in a network-free environment?

The device can still work without a network, and the data can be read in real time through the LCD screen view or RS485 interface.





For more frequently asked questions, please visit www.ubibot.com and go to the [Community and Documentation] page.

TECHNICAL SUPPORT

The UbiBot team is glad to hear your voice of our products and services.

For any questions or suggestions, please feel free to create a ticket in the UbiBot app. Our customer services representatives respond within 24 hours and often in less than an hour. You can also contact the local distributors in your country for localized service. Please go to our website to view their contacts.

PRODUCT MAINTENANCE INSTRUCTIONS

-  Please always follow the instructions contained in this manual.
-  Always mount the device on a stable surface.
-  Keep away from acidic, oxidising, flammable or explosive substances.
-  When handling the device, avoid using excessive force and never use sharp instruments to try and open it.

WARRANTY INFORMATION

1. The warranty period for this product is one year from the date of purchase. The buyer is required to submit a valid proof of purchase. During the warranty period, free repair will be provided for any failure caused by the quality of the product under normal use. The mailing cost of the returned product is the responsibility of the sender (one way).

2. The following cases are not covered by the warranty:

- ① The product is out of warranty;
- ② product failure or damage caused by incorrect or improper operation not in accordance with the product use instructions, configuration instructions, and product maintenance instructions;
- ③ accidental or man-made damage to the product, such as exceeding the temperature and humidity range of the equipment, water-caused damage, including natural water, such as water vapor, etc., fall, abnormal physical force, deformation, cable breakage, etc.;
- ④ damage due to natural wear and tear, consumption and aging, etc. (including shells, cables, etc.);
- ⑤ failure or damage caused by unauthorized dismantling of the product without permission;
- ⑥ failure or damage caused by force majeure, such as earthquake, fire, lightning strike, tsunami, etc.;
- ⑦ other non-product design, technology, manufacturing, quality and other issues caused by the failure or damage.

V1.0.0